

NSKV 1/2

Cable gland, polyamide

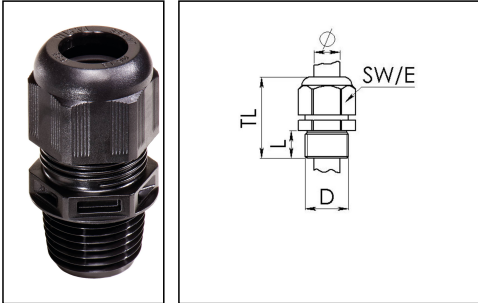

Products may differ in size, colour and appearance to those shown. If you require further information or customisation, please contact us directly.



Material cable gland	Polyamide
Material sealing gasket	EPDM
Temp. range min	-40 °C
Temp. range max	100 °C
Protection class	IP69, IP68 (5 bar 30 min)
Thread type	NPT
Ø Connection thread D	1/2"
Length screw-in thread L	15 mm
Ø cable diameter min	6 mm
Ø cable diameter max	13 mm
Ø cable diameter UL	7,5 mm - 11,3 mm
Key width SW	24 mm
Collar diameter (E)	27 mm
Total length TL	42 mm - 51 mm
Glow wire test	750 °C
Install. torques cap nut	3 N/m
Type of cable anchorage	A
Install. torques fitting	4 N/m
Impact category	2
Product Color	RAL 9005
Order no. RAL 9005	10061906
Type	NSKV 1/2
Packing unit	50
ETIM-Classification	EC000441

Your Contact:

WISKA UK Ltd.

Unit 7, Hurling Way · St. Columb Major Business Park · TR9 6SX, St. Columb Major, Cornwall · Great Britain

☎ +44-12-08816062 · 📠 +44-12-08816708

info@wiska.co.uk · www.wiska.co.uk

Recommended accessories

RDE 20	10062185
BS 13	10064010

24.08.2019

Your Contact:

WISKA UK Ltd.

Unit 7, Hurling Way · St. Columb Major Business Park · TR9 6SX, St. Columb Major, Cornwall · Great Britain

 +44-12-08816062 ·  +44-12-08816708

info@wiska.co.uk · www.wiska.co.uk



Your Contact:

WISKA UK Ltd.

Unit 7, Hurling Way · St. Columb Major Business Park · TR9 6SX, St. Columb Major, Cornwall · Great Britain

☎ +44-12-08816062 · 📠 +44-12-08816708

info@wiska.co.uk · www.wiska.co.uk