

## BW 25L

BW Pack, brass gland and locknut, shroud



Products may differ in size, colour and appearance to those shown. If you require further information or customisation, please contact us directly.

<b>Material</b>	Brass
<b>Material shrouds</b>	PVC
<b>Packing unit</b>	2
<b>Temp. range min</b>	-80 °C
<b>Temp. range max</b>	300 °C
<b>Protection class</b>	IP20
<b>Thread type</b>	M
<b>Ø Connection thread D</b>	25
<b>Lead</b>	1,5
<b>Length screw-in thread L</b>	10 mm
<b>Ø cable diameter max</b>	25,4 mm
<b>Key width SW</b>	32 mm
<b>Collar diameter (E)</b>	35 mm
<b>Total length TL</b>	34 mm
<b>Type</b>	BW 25L
<b>WISKA-Order no.</b>	50101695

### Recommended accessories

<b>ORD-N 25</b>	50108502
-----------------	----------

29.04.2024

Your Contact:

**WISKA UK Ltd.**

Unit 7, Hurling Way · St. Columb Major Business Park · TR9 6SX, St. Columb Major, Cornwall · Great Britain

☎ +44-12-08816062 · 📠 +44-12-08816708

info@wiska.co.uk · www.wiska.co.uk

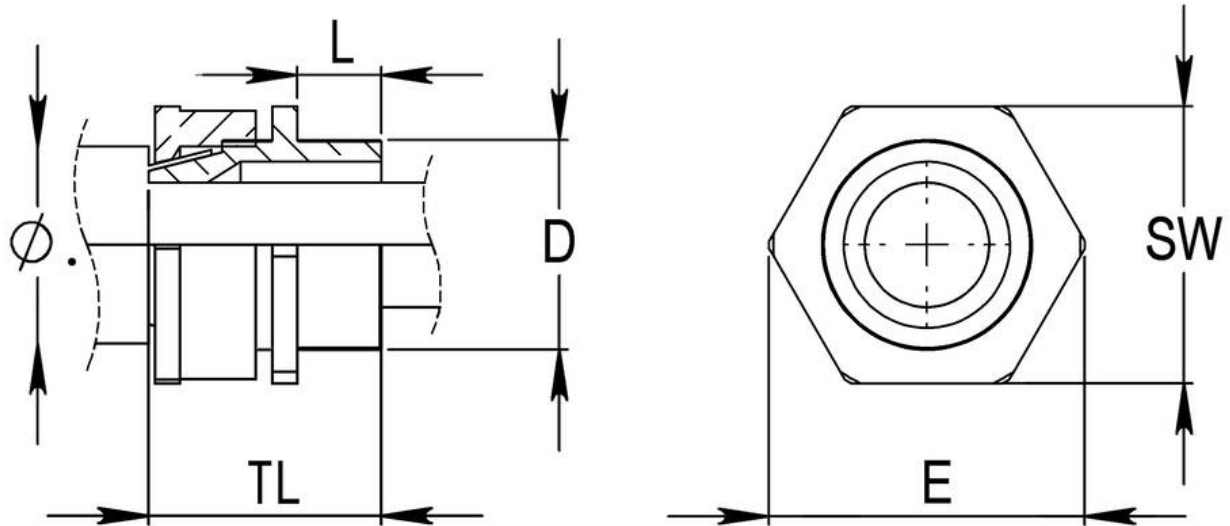

Your Contact:

**WISKA UK Ltd.**

Unit 7, Hurling Way · St. Columb Major Business Park · TR9 6SX, St. Columb Major, Cornwall · Great Britain

☎ +44-12-08816062 · 📠 +44-12-08816708

info@wiska.co.uk · www.wiska.co.uk