

BW 63L/LSF

BW LSF Pack, Low Smoke Fumes, brass gland and locknut, shroud LSF PVC



Products may differ in size, colour and appearance to those shown. If you require further information or customisation, please contact us directly.

Material	Brass
Material shrouds	PVC
Packing unit	1
Temp. range min	-80 °C
Temp. range max	300 °C
Protection class	IP20
Thread type	M
Ø Connection thread D	63
Lead	1,5
Length screw-in thread L	15 mm
Ø cable diameter max	64,7 mm
Key width SW	74 mm
Collar diameter (E)	83 mm
Total length TL	50 mm
Type	BW 63L/LSF
WISKA-Order no.	50108779

06.05.2024

Your Contact:

WISKA UK Ltd.

Unit 7, Hurling Way · St. Columb Major Business Park · TR9 6SX, St. Columb Major, Cornwall · Great Britain

☎ +44-12-08816062 · 📠 +44-12-08816708

info@wiska.co.uk · www.wiska.co.uk

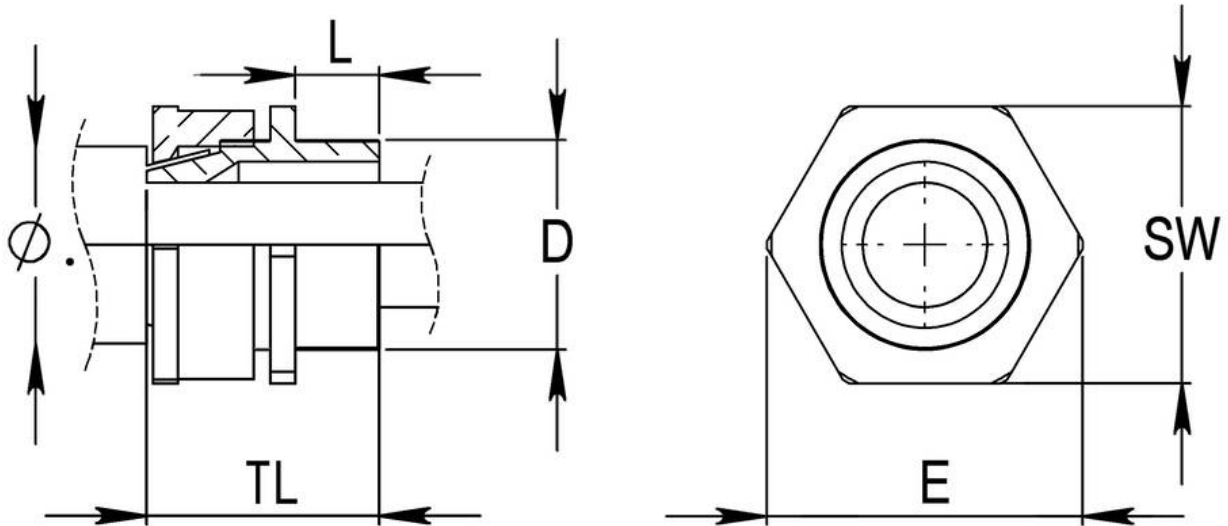

Your Contact:

WISKA UK Ltd.

Unit 7, Hurling Way · St. Columb Major Business Park · TR9 6SX, St. Columb Major, Cornwall · Great Britain

☎ +44-12-08816062 · 📠 +44-12-08816708

info@wiska.co.uk · www.wiska.co.uk