

## COMBI 607 LG

Junction box, polypropylene

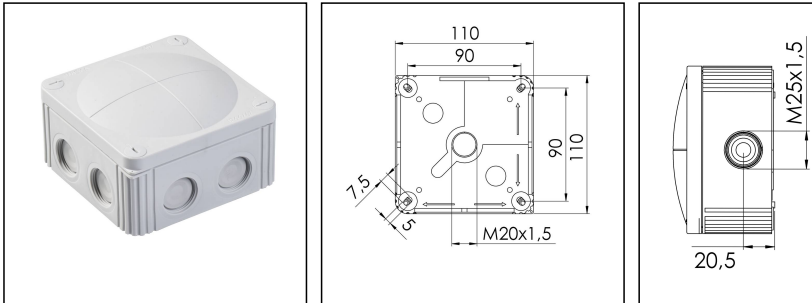

Products may differ in size, colour and appearance to those shown. If you require further information or customisation, please contact us directly.



<b>Material</b>	Polypropylene
<b>Material sealing gasket</b>	TPE
<b>Temp. range min</b>	-30 °C
<b>Temp. range max</b>	100 °C
<b>Temperatures during install.</b>	-5 °C - 60 °C
<b>Protection class</b>	IP66 / IP67
<b>Glow wire test</b>	750 °C
<b>Voltage</b>	690 V
<b>Rated cross section</b>	6 mm <sup>2</sup>
<b>Fixing</b>	4 internal openings
<b>Ø cable diameter min</b>	5,2 mm
<b>Ø cable diameter max</b>	17 mm
<b>External dimensions LxWxH</b>	110 x 110 x 66mm
<b>Using for cable gland</b>	
<b>Product Color</b>	RAL 7035
<b>WISKA-Order no.</b>	10060531
<b>Type</b>	COMBI 607 LG
<b>Packing unit</b>	3
<b>EAN number</b>	4007685605311
<b>Tariff number</b>	39269097
<b>ETIM-Classification</b>	EC002600

Remarks:

IP66: using the membrane entry

IP67: using the threaded entry together with ESKV cable gland

Your Contact:

**WISKA UK Ltd.**

Unit 7, Hurling Way · St. Columb Major Business Park · TR9 6SX, St. Columb Major, Cornwall · Great Britain

☎ +44-12-08816062 · 📠 +44-12-08816708

info@wiska.co.uk · www.wiska.co.uk

**Equipment:**

- 7 M25 threaded membrane entries
- 3 membrane cable entries through rear
- 4 captive cover screws

**Mounting:**

- 4 internal openings outside of the sealing area

**Recommended accessories**

DIN Rail Kit - COMBI 607/TS 35	10060361
MP-L Mounting plate large COMBI / WHK	10105775
External mounting - COMBI LG	10108836
SP-HKT 607 Terminal block	22000407

29.04.2024

**Your Contact:**

**WISKA UK Ltd.**

Unit 7, Hurling Way · St. Columb Major Business Park · TR9 6SX, St. Columb Major, Cornwall · Great Britain

☎ +44-12-08816062 · 📠 +44-12-08816708

info@wiska.co.uk · www.wiska.co.uk

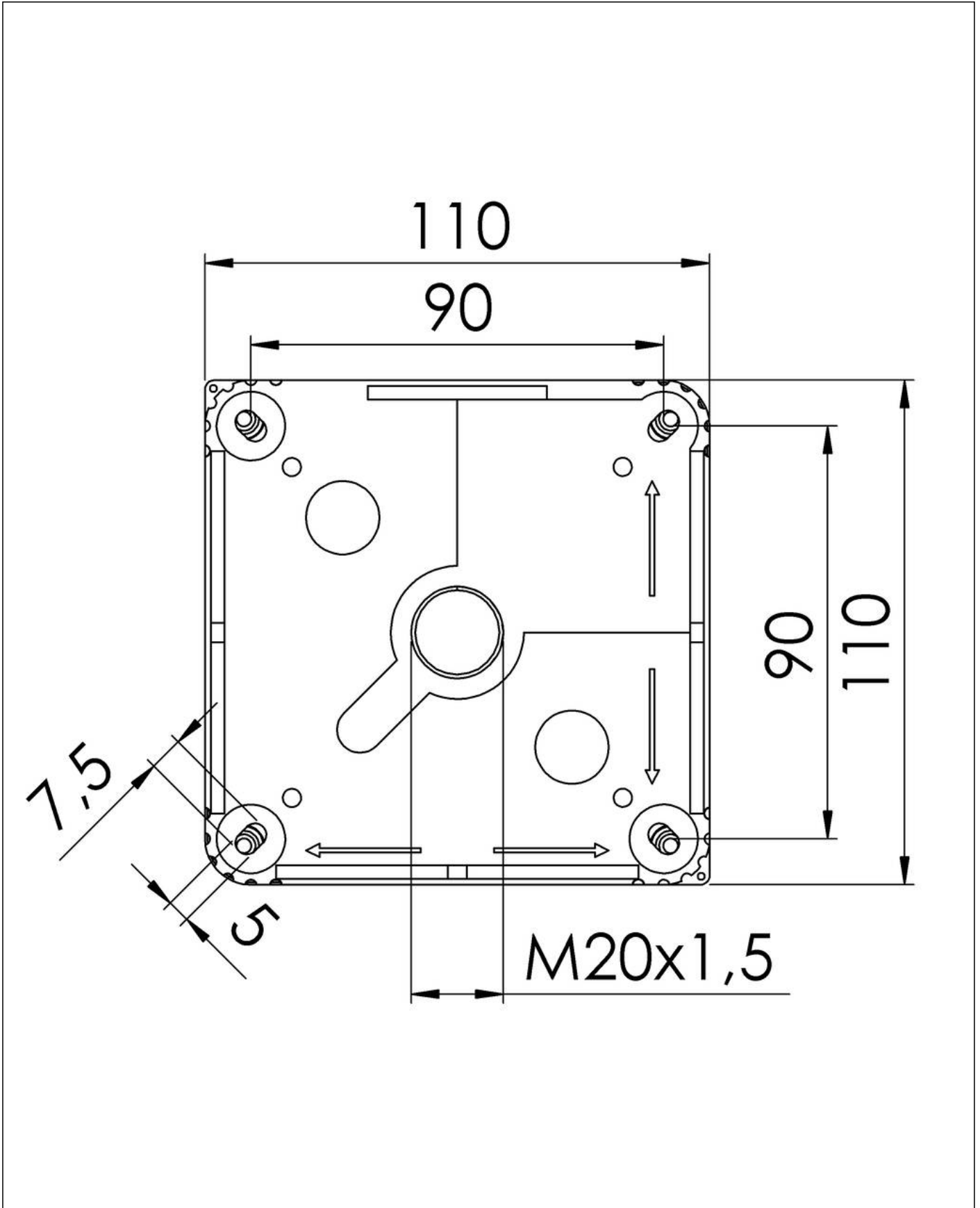

Your Contact:

**WISKA UK Ltd.**

Unit 7, Hurling Way · St. Columb Major Business Park · TR9 6SX, St. Columb Major, Cornwall · Great Britain

☎ +44-12-08816062 · 📠 +44-12-08816708

info@wiska.co.uk · www.wiska.co.uk

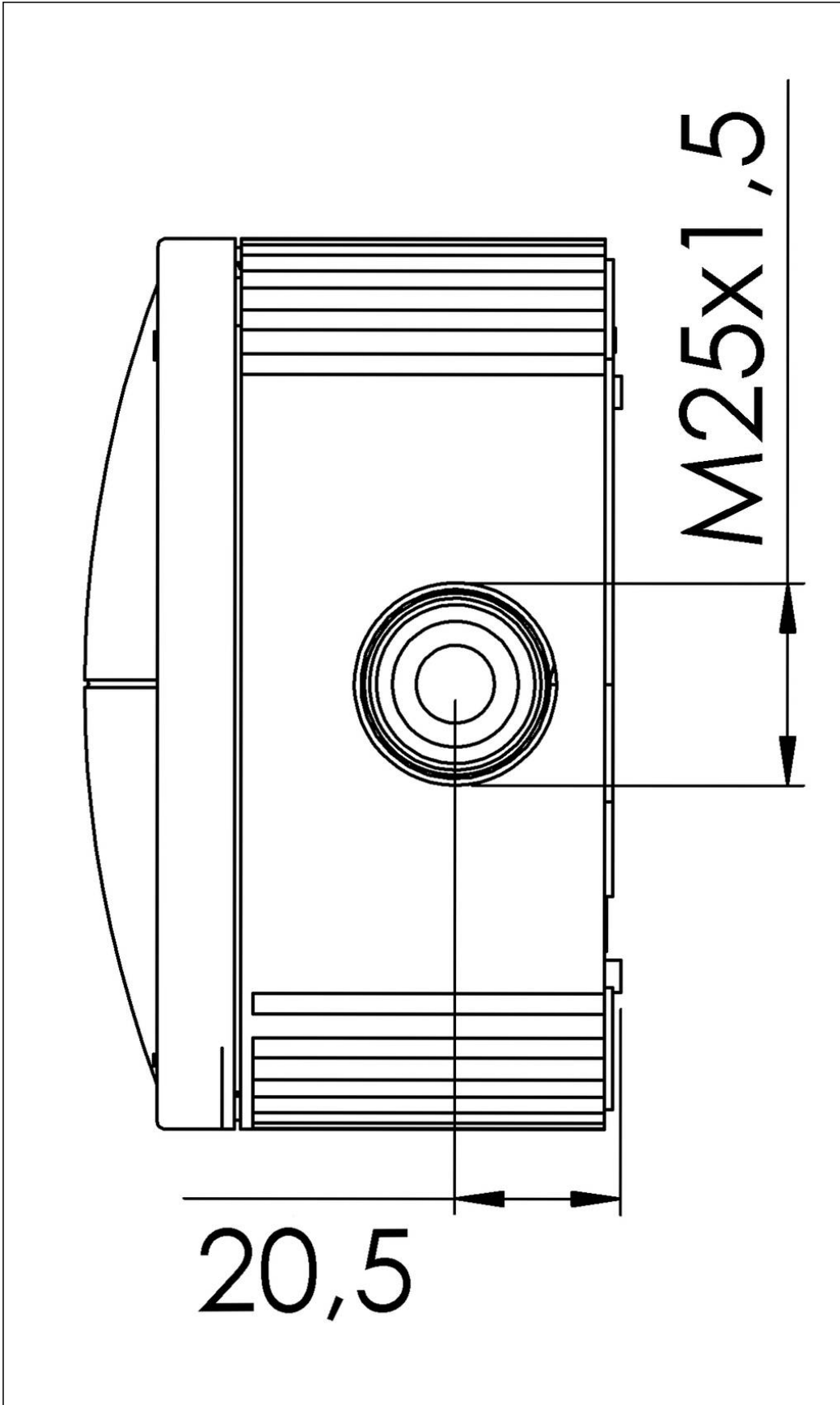

Your Contact:

**WISKA UK Ltd.**

Unit 7, Hurling Way · St. Columb Major Business Park · TR9 6SX, St. Columb Major, Cornwall · Great Britain

☎ +44-12-08816062 · 📠 +44-12-08816708

info@wiska.co.uk · www.wiska.co.uk