

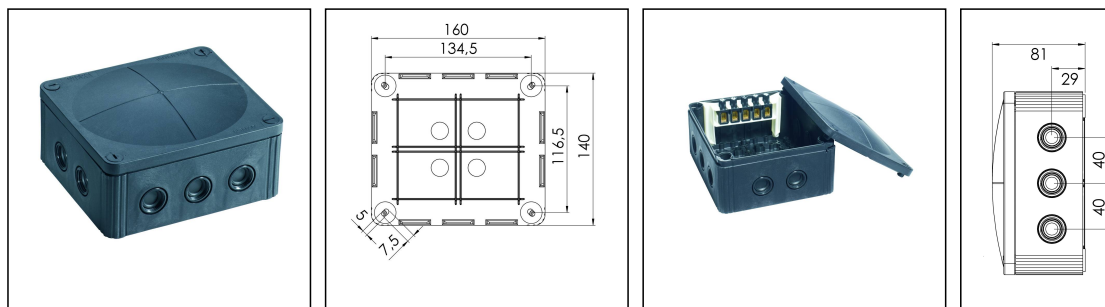

## COMBI 1210/5 BK

Junction box, polypropylene



Products may differ in size, colour and appearance to those shown. If you require further information or customisation, please contact us directly.



<b>Material</b>	Polypropylene
<b>Material sealing gasket</b>	TPE
<b>Temp. range min</b>	-30 °C
<b>Temp. range max</b>	100 °C
<b>Temperatures during install.</b>	-5 °C - 60 °C
<b>Protection class</b>	IP66 / IP67
<b>Glow wire test</b>	750 °C
<b>Voltage</b>	690 V
<b>Rated current / A (Terminal)</b>	57 A
<b>Rated cross section</b>	10 mm <sup>2</sup>
<b>Terminals/poles</b>	5-pole, 10,0 mm <sup>2</sup>
<b>Fixing</b>	4 internal openings
<b>Ø cable diameter min</b>	3 mm
<b>Ø cable diameter max</b>	12 mm
<b>External dimensions LxWxH</b>	160 x 140 x 81mm
<b>Using for cable gland</b>	
<b>Product Color</b>	RAL 9005
<b>WISKA-Order no.</b>	10101463
<b>Type</b>	COMBI 1210/5 BK
<b>Packing unit</b>	2
<b>EAN number</b>	4007685016650
<b>Tariff number</b>	85369010
<b>ETIM-Classification</b>	EC002600

Remarks:

Your Contact:

**WISKA UK Ltd.**

Unit 7, Hurling Way · St. Columb Major Business Park · TR9 6SX, St. Columb Major, Cornwall · Great Britain

☎ +44-12-08816062 · 📠 +44-12-08816708

info@wiska.co.uk · www.wiska.co.uk

**IP66:** using the membrane entry

**IP67:** using the threaded entry together with ESKV cable gland

**Equipment:**

- 10 M20 threaded membrane entries and M25 knockouts
- 4 membrane cable entries through rear
- 4 captive cover screws
- inclusive terminal block 5-poles, 10mm<sup>2</sup>

**Mounting:**

- 4 internal openings outside of the sealing area

**Recommended accessories**

<b>MP-L Mounting plate large COMBI / WHK</b>	10105775
<b>External mounting - COMBI LG</b>	10108836
<b>ZER 4-12 LG</b>	10109800

**Spare parts**

<b>SP-HKT 1010 Terminal block</b>	22000408
-----------------------------------	----------

20.05.2024

Your Contact:

**WISKA UK Ltd.**

Unit 7, Hurling Way · St. Columb Major Business Park · TR9 6SX, St. Columb Major, Cornwall · Great Britain

☎ +44-12-08816062 · 📠 +44-12-08816708

info@wiska.co.uk · www.wiska.co.uk

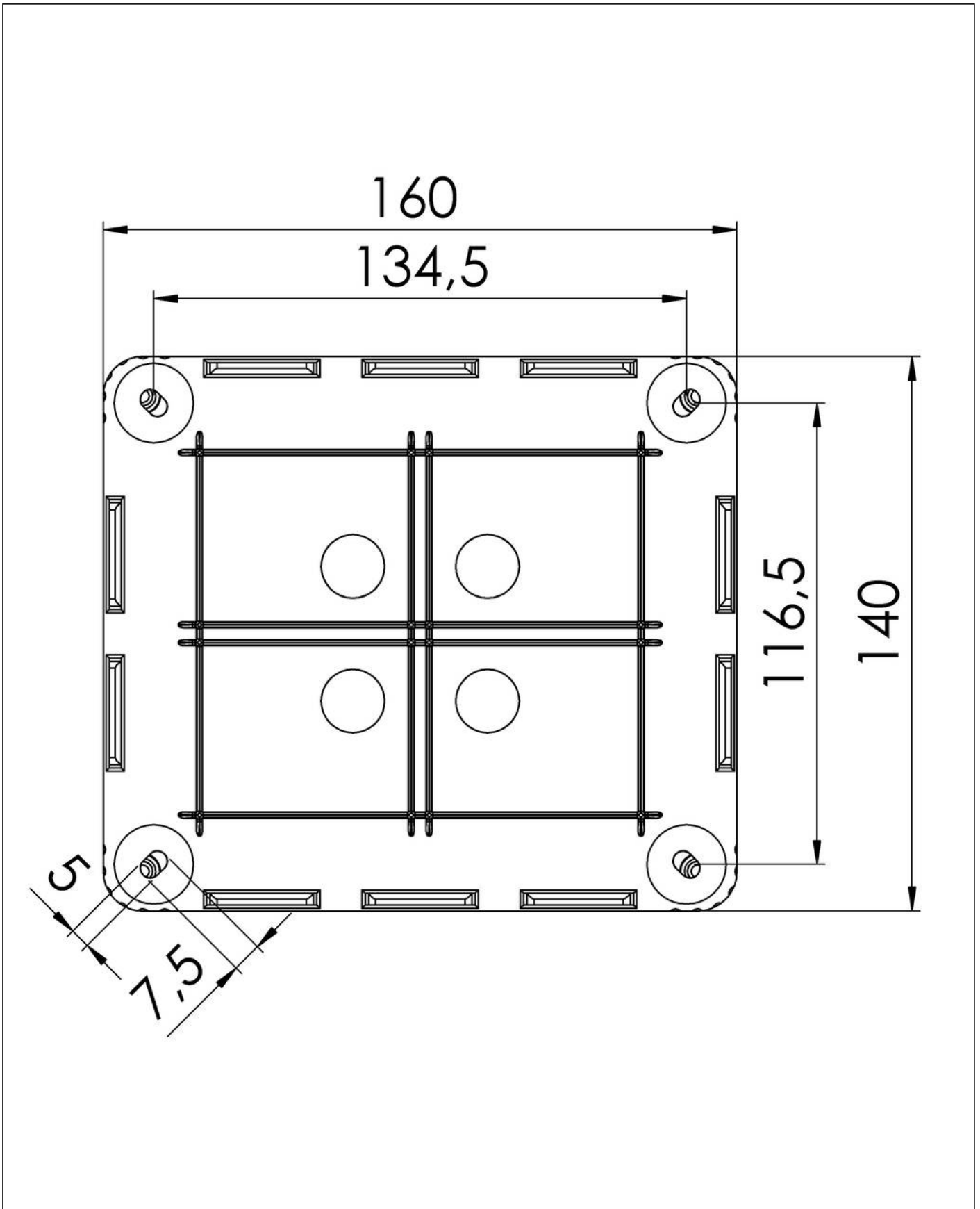

Your Contact:

**WISKA UK Ltd.**

Unit 7, Hurling Way · St. Columb Major Business Park · TR9 6SX, St. Columb Major, Cornwall · Great Britain

☎ +44-12-08816062 · 📠 +44-12-08816708

info@wiska.co.uk · www.wiska.co.uk

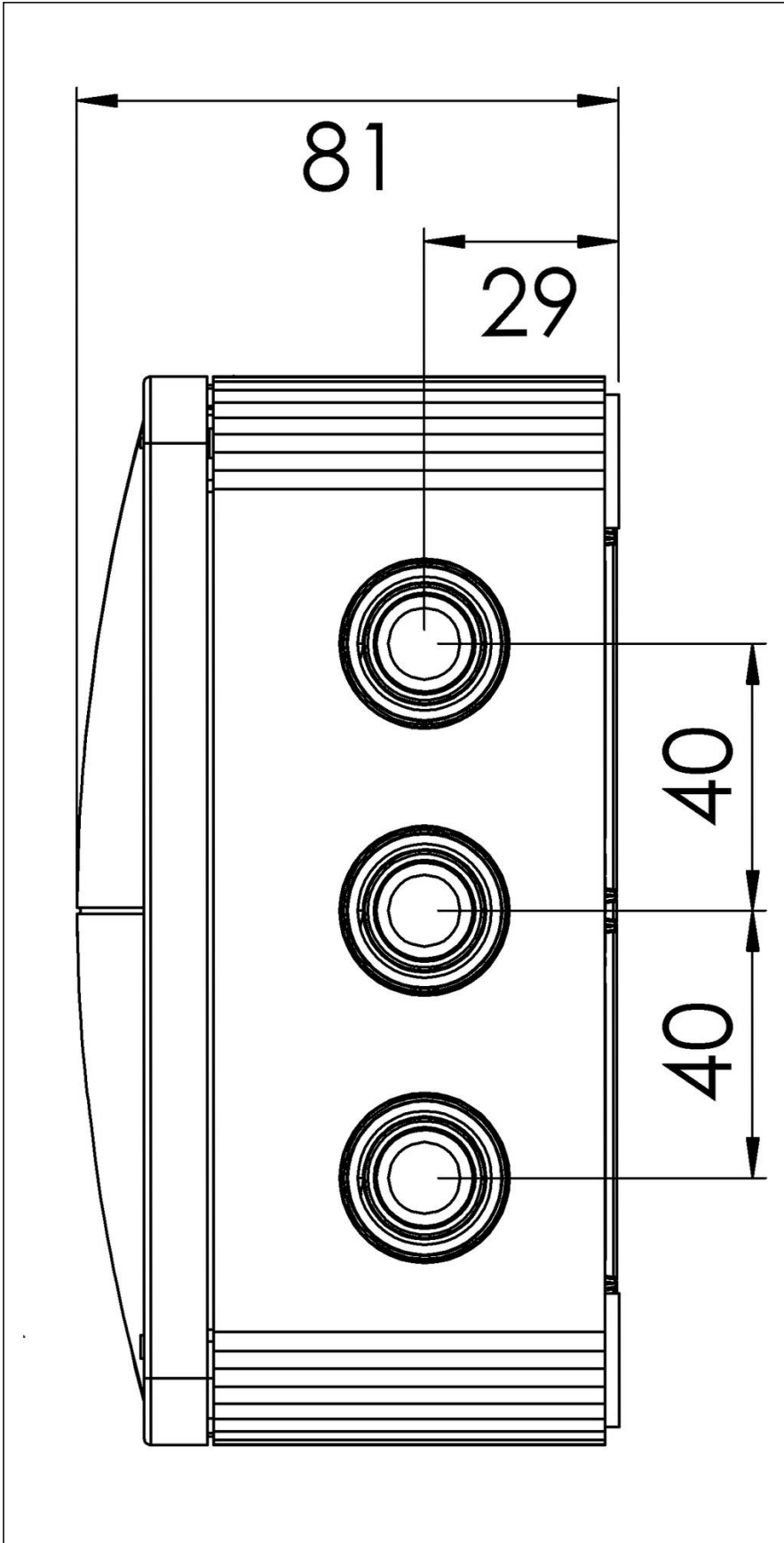

Your Contact:

**WISKA UK Ltd.**

Unit 7, Hurling Way · St. Columb Major Business Park · TR9 6SX, St. Columb Major, Cornwall · Great Britain

☎ +44-12-08816062 · 📠 +44-12-08816708

info@wiska.co.uk · www.wiska.co.uk